

1 2 3 4

REV.	ECN NO.	DATE
01	Modify Drawing	20100628
02	Add dimensions	20100819
03	Add dimensions	20110217
04	Add partnumber	20110709
05	Add dimensions	20110715
06	Modify STAND-OFF ADD EON DIMENSION	20120306
07	MODIFY LIGHTPIPE DIMENSION	20120324
08	MODIFY EON DIMENSION AND STAND FEET	20120710
A	MODIFY EON DIMENSION AND STAND FEET	20121207

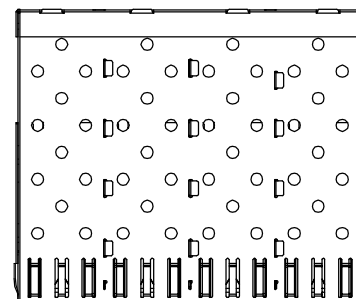

CAGE W/O LIGHT PIPE

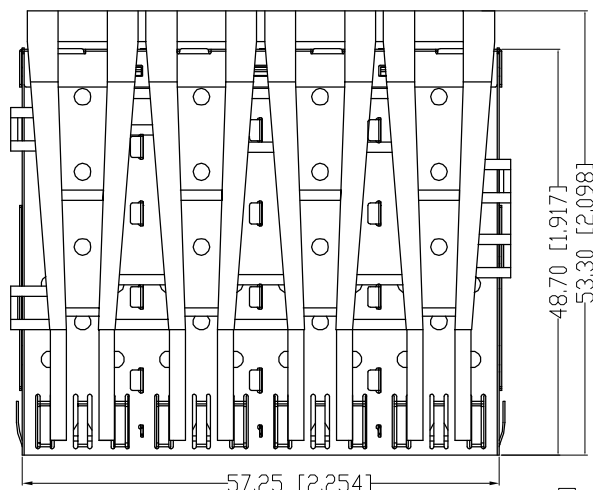
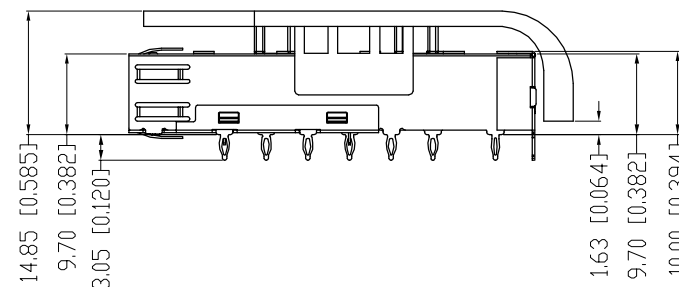
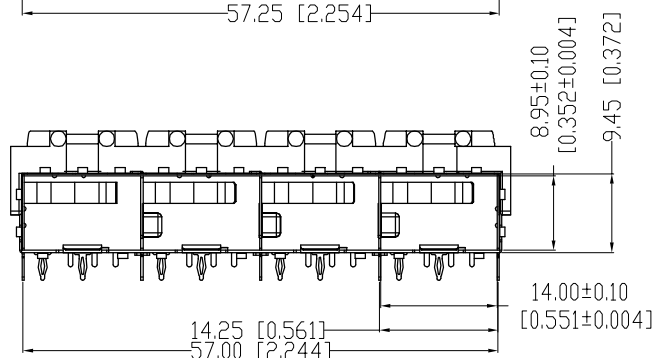

NOTE:

1, DESCRIPTION	Q'ty	MATERIAL	PLATING
01 SFP CAGE	1PCS	COPPER ALLOY T=0.25	N/A
02 LIGHTPIPE	1PCS	POLYCARBONATE. UL 94V-0 COLOR:CLEAR	N/A

2, TEMPERATURE:

OPERATION: -55°C~+105°C
STORAGE: -55°C~+105°C

3, INSERTION AND EXTRACTION FORCE: 40N MAX & 11.5 MAX

4, DURABILITY: 100 CYCLES MIN.

RoHS Compliant

PART NUMBER	DESCRIPTION
K869-00-Y024	SFP 1X4 CAGE (Press-fit) W/ LOGO
K869-00-Y070	SFP 1X4 CAGE (Press-fit) W/O LOGO

				TOLERANCES		Material: SEE NOTE		Designed: Jacky Fu		NAME: SFP 1X4 CAGE W/ LIGHT PIPE		
				.0 ± 0.25 .00 ± 0.20 .000 ± 0.10		Finish: SEE NOTE		Checked: Bob Gu		DWG NO: ESFP09091001-C		REV.
		A4		SCALE	UNIT	CUSTOMER: N/A	SHEET 1 OF 2		Approved: Neil_Cheng		PART NO: SEE TABLE	
THIRD ANGLE PROJECTION		SIZE		1:1	mm	MODEL NO: N/A					A	

1 2 3 4

REV.	ECN NO.	DATE
01	Modify Drawing	20100628
02	Add dimensions	20100819
03	Add dimensions	20110217
04	Add partnumber	20110709
05	Add dimensions	20110715
06	Modify STAND-OFF ADD EON DIMENSION	20120306
07	MODIFY LIGHTPIPE DIMENSION	20120323
08	MODIFY EON DIMENSION AND STAND FEET	20120710
A	MODIFY EON DIMENSION AND STAND FEET	20121207

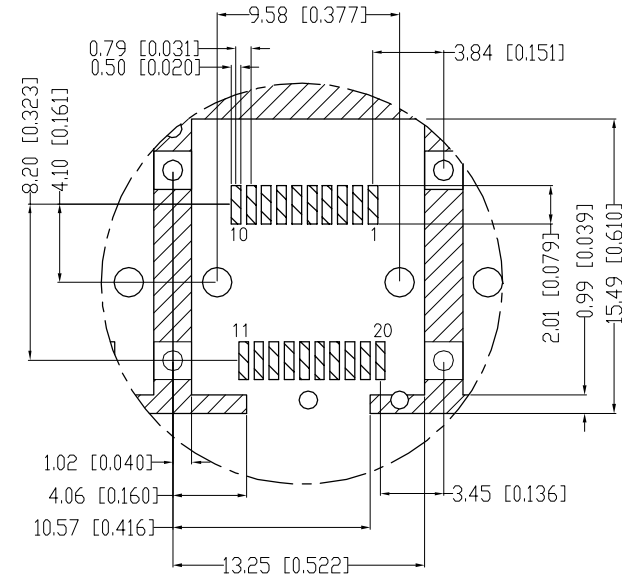
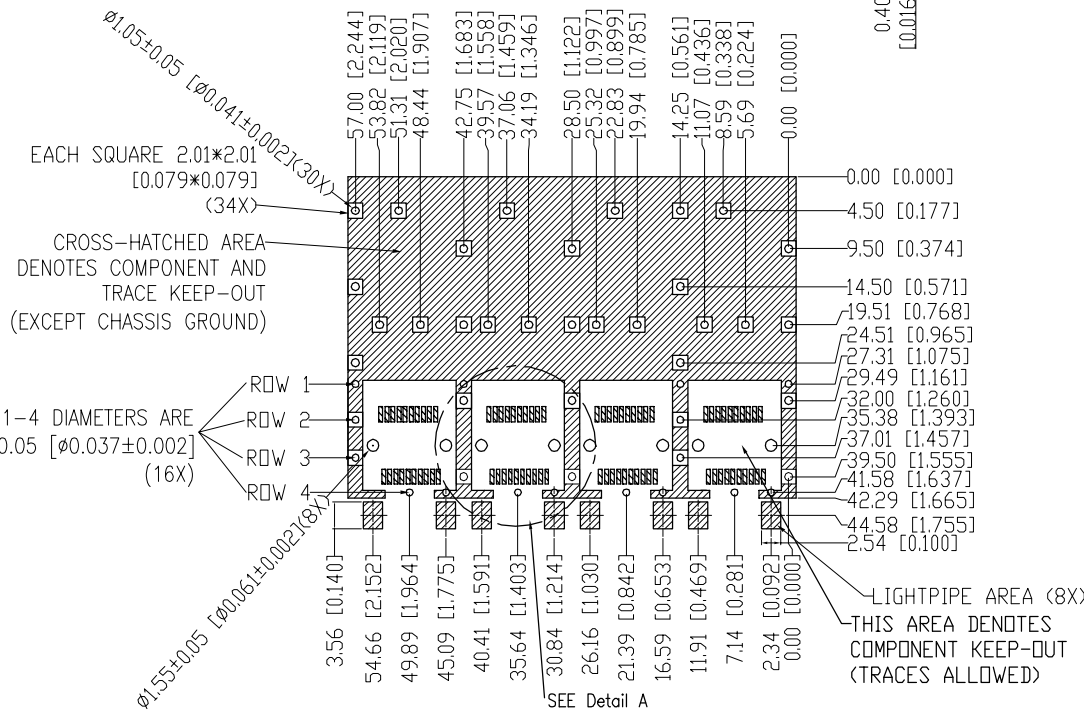
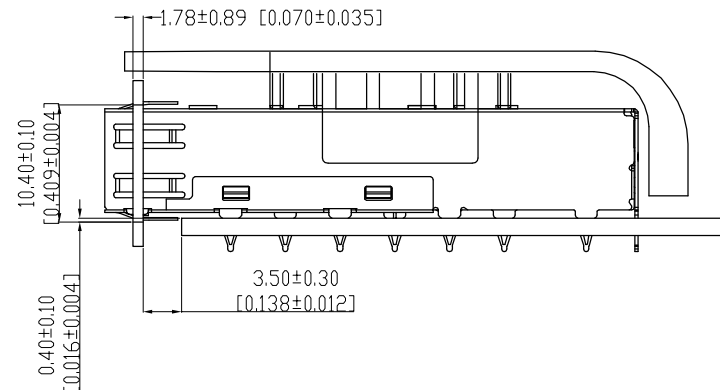
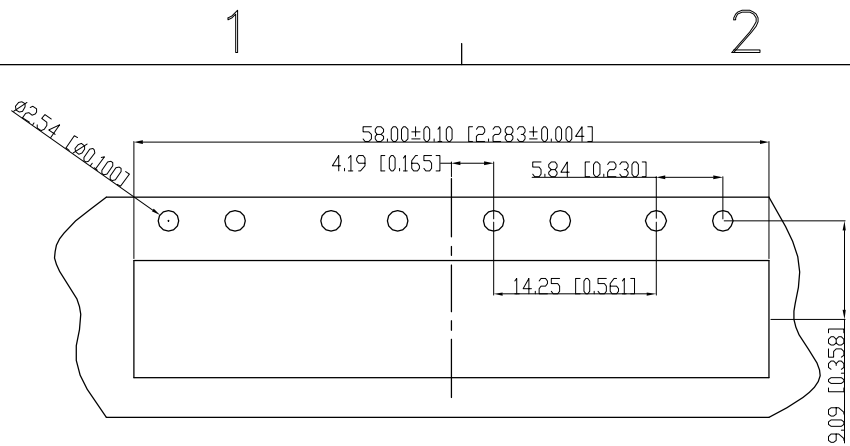

PCB LAYOUT THICKNESS=3.0MM (TOP VIEW)

SEE Detail A
SCALE 2.5:1

RoHS Compliant

库乐科技

TOLERANCES

.0 ± 0.25
.00 ± 0.20
.000 ± 0.10

ANGLES ± 0.5

Material: SEE NOTE

Designed: Jacky Fu

NAME: SFP 1X4 CAGE W/ LIGHT PIPE

Finish: SEE NOTE

Checked: Bob Gu

DWG NO: ESFP09091001-C

SHEET 2 OF 2

Approved: Neil_Cheng

PART NO: SEE TABLE

REV.

A



A4
SIZE

SCALE
1:1

UNIT
mm

CUSTOMER: N/A
MODEL NO: N/A